

FWB1004-J

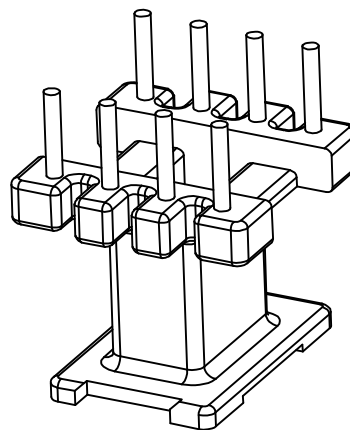
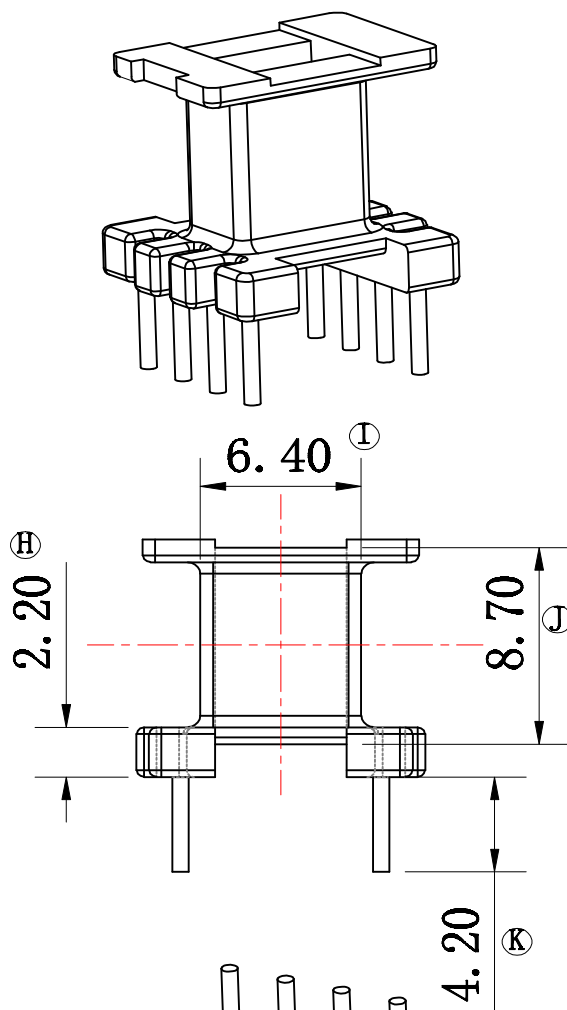
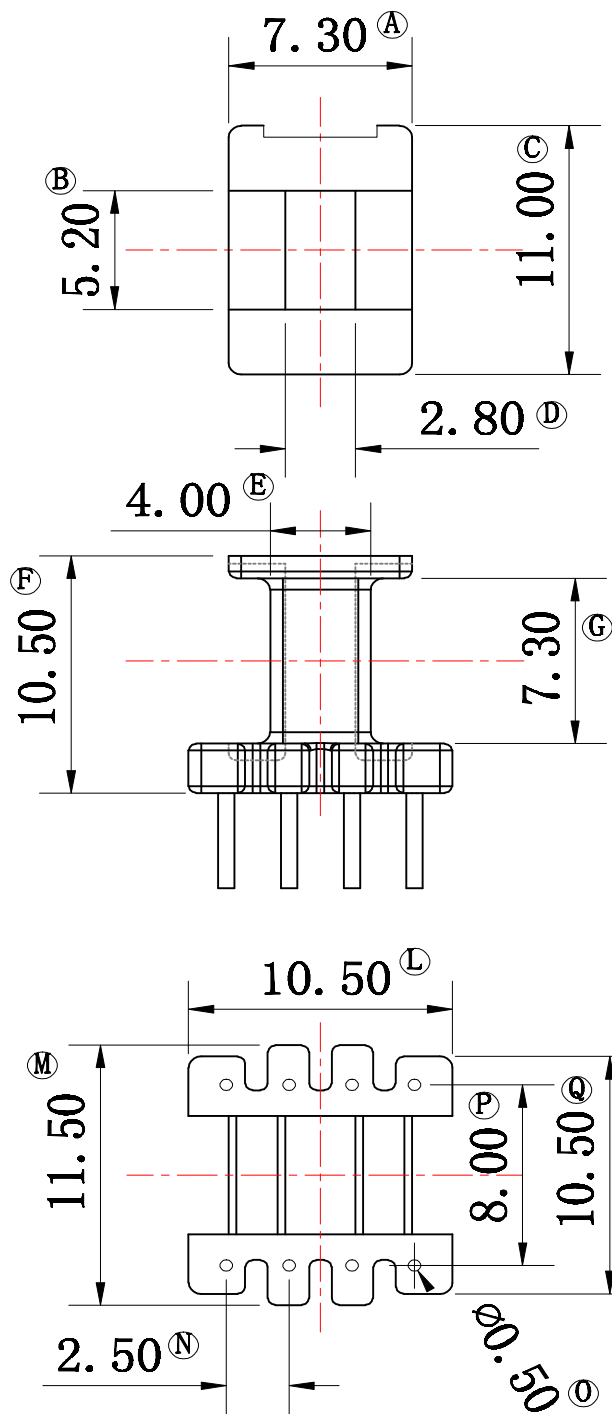

REV	REVISION RECORD	DATE	REV	REVISION RECORD	DATE
A			C		
B			D		

NAME	EE10 4+4P	MATERIAL	PHENOLIC	SCALE		ANGLE	$\pm 1^\circ$
DRAWING NO.	FWB1004-J	PIN MATERIAL	CP WIRE	UNIT	m/m	REV	A
TOLERANCE OF PIN PITCH ± 0.20				HAINING FERRIWO ELECTRONICS CO.,LTD.			
PIN TENSION LOAD kg MN		UL REC: 94V-0		TEL: +86-573-87088701 FAX: +86-573-87081130			
TOLERANCE: 0<L≤4: ±0.2 4<L≤16: ±0.3 16<L≤63: ±0.4				Web: www.ferriwo.com Email: sales@ferriwo.com			